



Interactive Collection.

PRODUCT CATALOG 2020

OUTFORM™

©2020 OUTFORM™ All RIGHTS RESERVED.

MOTION SENSOR EXPERIENCE



DRAW SHOPPERS IN FROM A DISTANCE

Designed to catch the attention of passing customers, the Motion Sensor can be added to any OSM pairing to create different triggers for different distances. Drawing shoppers in as they approach, the motion sensor can invite users to specific display interactions depending on how close or far they are standing.

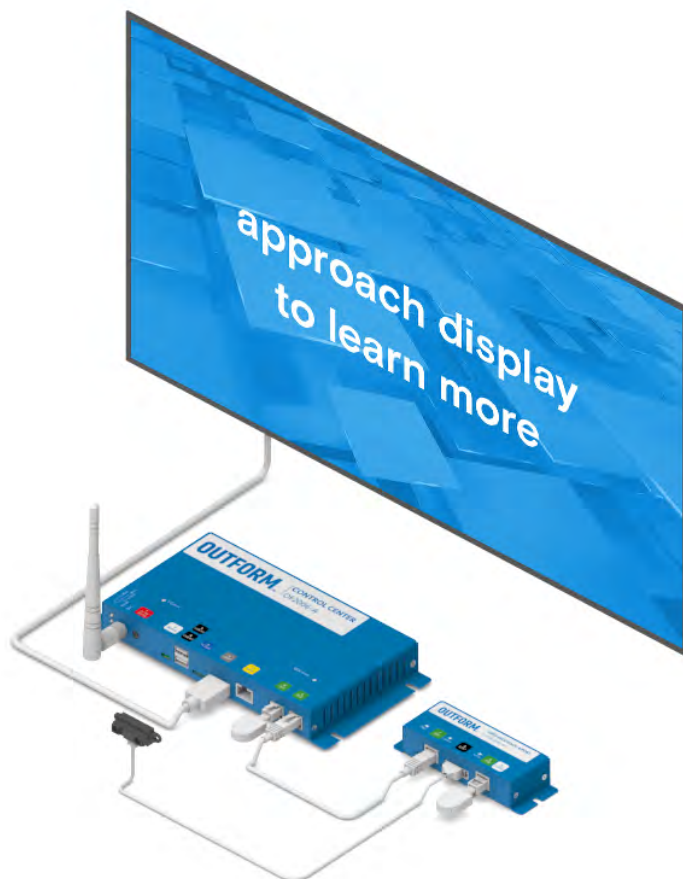



MOTION SENSOR EXPERIENCE

MULTIPLE DISTANCE DETECTION

The Motion Sensor is programmed to display relevant content according to the users distance from the display. For example: a user standing 80 cm away will trigger a message to invite the user to approach the display, while a user standing 30 cm away will trigger product specific content.

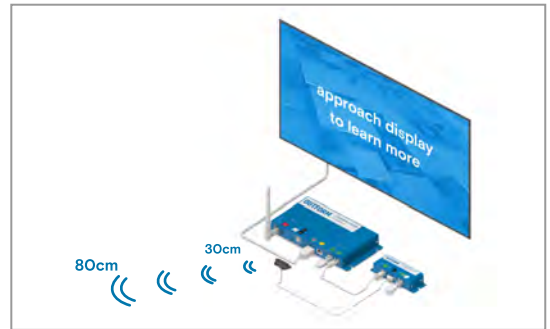

SECURELY MOUNTS

The motion sensor can be securely mounted on any flat surface, horizontally, vertically, or angled.



MODULAR

The Interactive Collection is comprised of a variety of Outform Standard Modules (OSM) which communicate by way of ODC protocol. ODC protocol enables a dynamic eco-system by which multiple OSMs can interact and trigger relevant experiences.

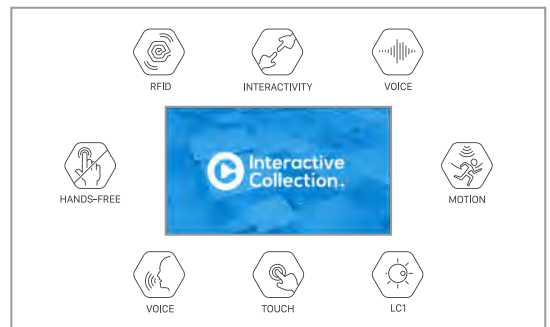

INTERACTIVITY

By combining this experience with different sensors and triggers, this experience can support a combination of user interactions such as touch, voice, motion, and many more.



CUSTOM TRIGGERS

The sensor allows for specific content to be triggered for different distances.

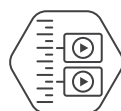

VARIOUS RANGES

The sensor has available options for short, medium or long range detection.



OIE

Outform Interactive Editor gives you the tools to create your own experiences with ease using Control Center configuration



PRODUCT SIZE

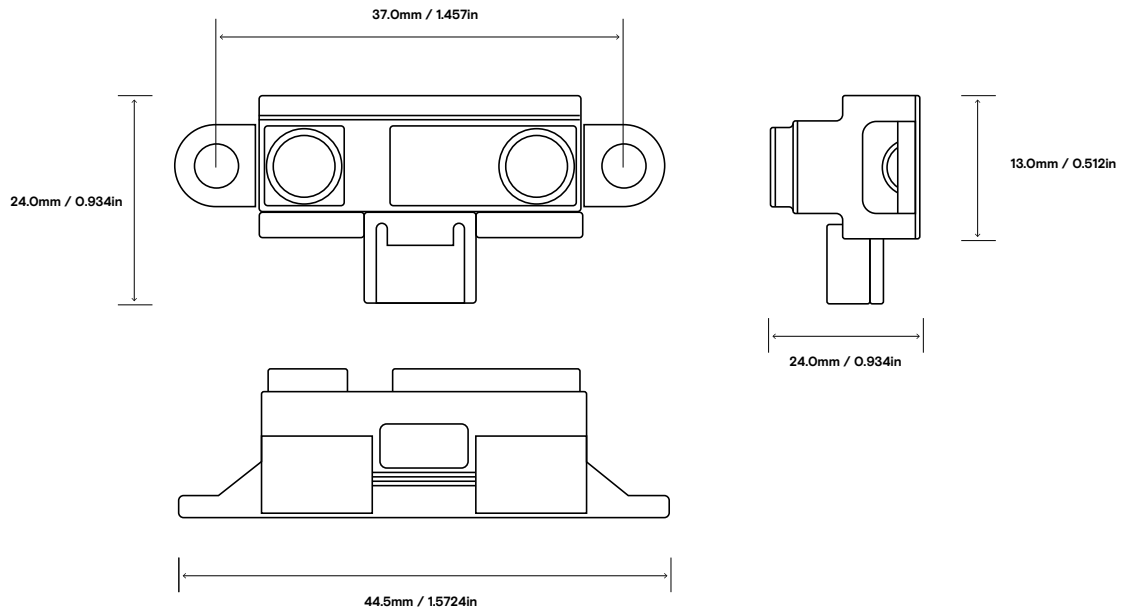

DETECTION RANGE

10-80CM

OPERATING TEMPERATURE

-20-50C

OPERATING VOLTAGE

5V DC (VIA OSM GPIO)

POWER CONSUMPTION

50MA

CABLE LENGTH

0.5 METER

CERTIFICATIONS

CE, ROHS



FAQ

WHAT IS THE DETECTION RANGE OF THE MOTION SENSOR?

The detection range is 20cm – 80cm.

HOW MANY MOTION SENSORS CAN ONE SYSTEM SUPPORT?

As many as needed. The Interactive Collection is designed to add any number of sensors and triggers to any experience.

CAN THE MOTION EXPERIENCE HELP TO SAVE ENERGY?

Yes, we can program the Motion Experience to switch on and off any screen or product that does not need to work when there is no interaction.

CAN THE MOTION SENSOR AND THE GESTURE SENSOR WORK TOGETHER ON THE SAME SYSTEM?

Yes, add as many sensors as you need to one system.



MOTION SENSOR EXPERIENCE KITS

MOTION SENSOR BASIC

UIC7001-01

Use the motion sensor to set custom triggers as shoppers pass by.

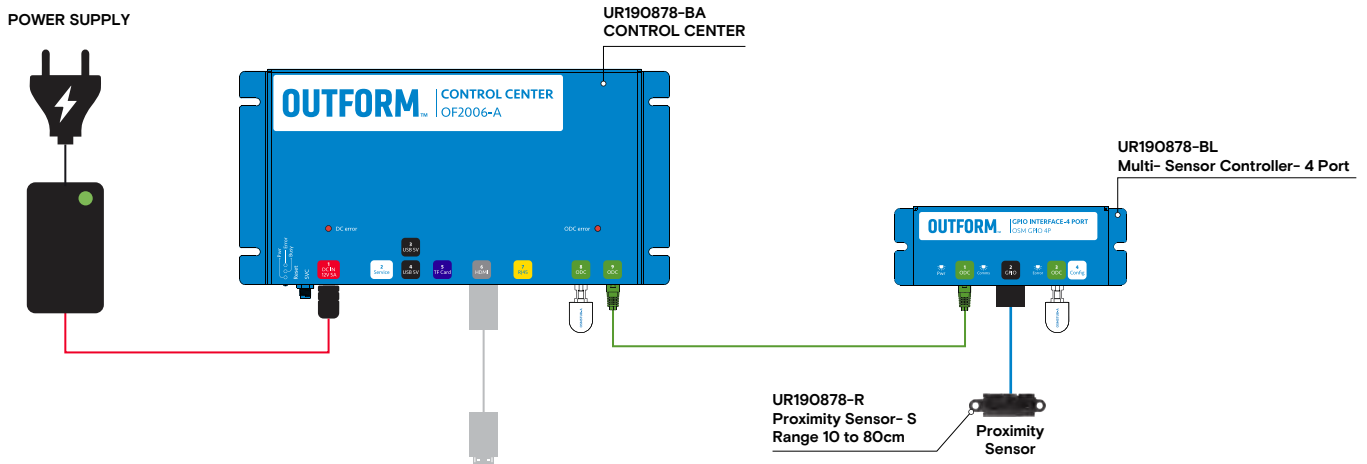

MOTION SENSOR + RGB LED CONTROLLER + BUTTONS

UIC7002-01

Use the motion sensor and RGB LED Controller to set custom triggers and engage shoppers as they pass by. Incorporate buttons to create a responsive experience as they approach the display.

[Click here](#) to watch the system build tutorial.

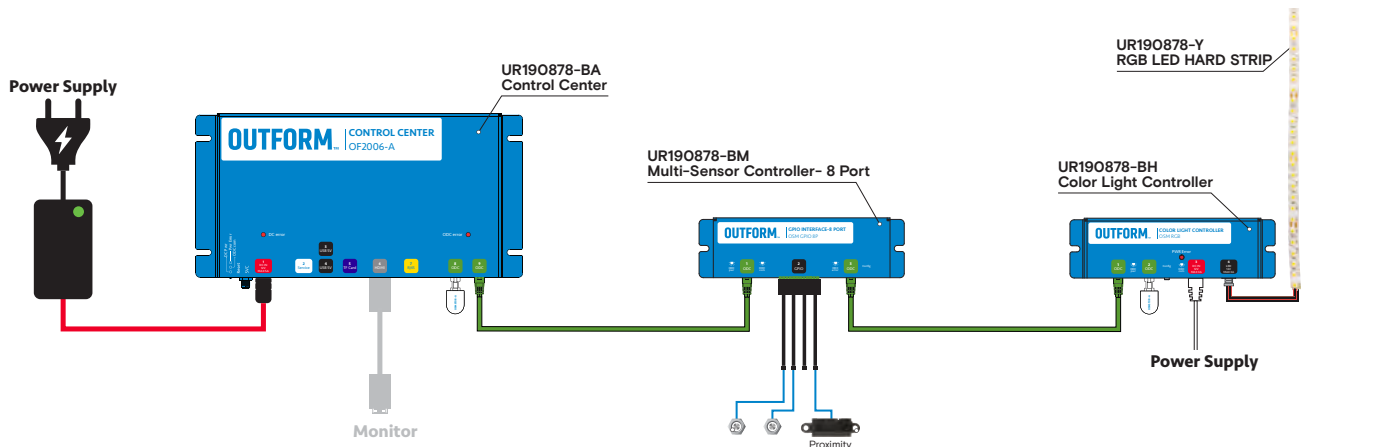

- AC CABLE
- 12V DC CABLE
- ODC RJ25 CABLE
- AUDIO CABLE
- USB CABLE
- HDMI CABLE
- GPIO CABLE
- RFID CABLE



MOTION SENSOR EXPERIENCE KITS

MOTION SENSOR + WHITE LIGHT CONTROLLER

UIC7003-01

As users approach the display, the white light intensifies and custom triggers appear on screen.

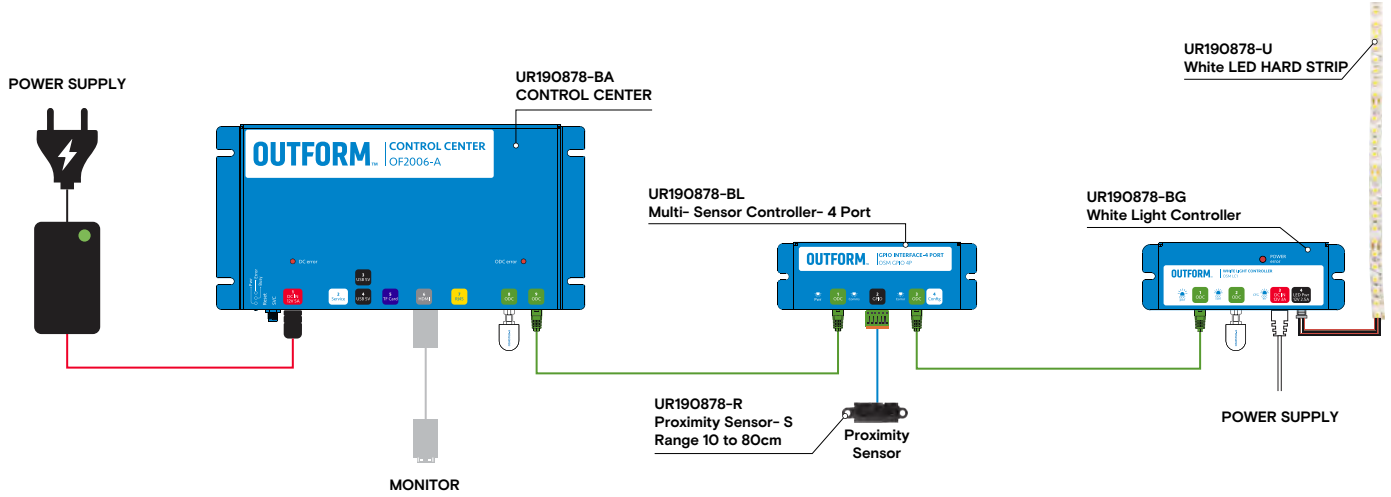

- AC CABLE
- 12V DC CABLE
- ODC RJ25 CABLE
- AUDIO CABLE
- USB CABLE
- HDMI CABLE
- GPIO CABLE
- RFID CABLE